



Traditionally, X-ACTO® cutting tools have set industry standards for quality construction and performance. They are the knives and blades of choice for the professional designer and graphic artist.



KNIVES

X-2000™

This safe and stylish knife has a no-slip rubberized comfort grip with anti-roll wedge, a center-barrel blade release and a safety cap. Designed for delicate, precision cutting, trimming and stripping, it cuts paper, plastic, balsa, thin metal, cloth, film and acetate. Includes No. 11 Classic Fine Point Blade.



No. 1 Precision Knife

A 5" anodized lightweight aluminum handle with a No. 11 blade and safety cap. For delicate precision cutting, trimming and stripping. Cuts paper, plastic, balsa, thin metal, cloth, film and acetate.



No. 2 Medium Weight Precision Knife

A 5" aluminum handle with a No. 2 blade for cutting medium to heavyweight materials. Cuts wood, board, paper, plastic, metal, film and acetate.



Gripster™ Soft Grip Knife

Use for lightweight cutting of paper, plastic, balsa, thin metal, cloth, film and acetate. Features a rubberized barrel for comfort and control, safety cap and rear blade release for easy, safe replacement. Includes No. 11 Classic Fine Point Blade.



Surgrip Utility Knife

Features a textured handle shaped to fit your hand and adjustable cutting depths. Cuts packages, rope, canvas, plastic, carpet and wallpaper. Includes a Heavy-Duty Utility Blade. Available with metal or plastic handle.



BLADES



No. 11 Classic Fine Point



No. 11 Stainless Steel



No. 10 General Purpose



No. 16 Scoring



No. 22 Large Curved Carving



No. 23 Corner Stripping



No. 24 Deburring

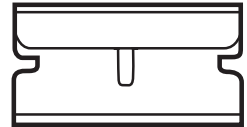

Single Edge Razor (70)



Heavy Duty Utility Blade (92)



midwest

sign & screen printing supply co.

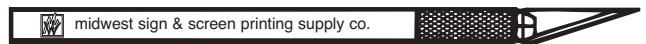

Midwest Hobby Knife & Blades

Features a polished aluminum handle (4 5/8" x 5/8") and a clear plastic safety cap. Use this knife for delicate, precision cutting of lightweight materials. Includes one blade. Replacement blade packs available.

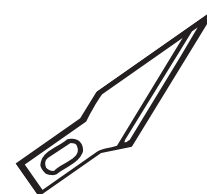

Compares with X-ACTO No. 1 knife and Grifhold No. 7 knife.

Replacement blades compare with X-ACTO No. 11 blades and Grifhold No. 7E blades.





Griffin Manufacturing has been designing and manufacturing precision hand tools for over 50 years. With a wide variety of knives, blades and specialty tools, there is a Grifhold product for almost every application.

KNIVES

No. 7 Hobby Knife

Designed for precision cutting of lightweight materials. Includes one #7E blade and will also accept #7A, #7B, #7C, #7D and #7F blades.



No. 8 Medium Weight Knife

Use for precision cutting of medium-weight materials. Includes one #8A blade and accepts the #8 Series blades.



No. 14 Heavy Weight Knife

Use for heavy-pressure cutting of heavyweight materials. Includes one #8A blade and accepts the #8 Series blades.



No. 24 Streamlined Stencil Knife

For cutting stencils, etching, retouching, scribing, trimming, perforating. Includes one #7B blade and accepts the #24E blades.



No. 113 Swivel Knife

Swivels free and easy for cutting arcs, curves, circles. Blade locks for straight work. Includes one #113B blade.

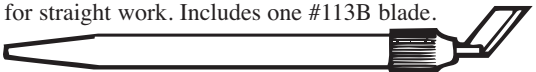

No. 114 Swivel Craft Knife

Swivel Blade rotates 360 degrees for cutting circles and curves. Blade locks for straight work. Includes #114B blade.



No. 119 Retractable Medium-Duty Safety Knife

For precision cutting, trimming, etching and scoring. Twist handle to lock blade inside for safety. Includes #119J Double Grind Blade.

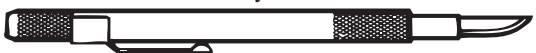

No. 111 Heavy-Duty Utility Knife

Gray lacquered finish utility knife. Use for heavy-duty cutting. Includes one #112B blade.

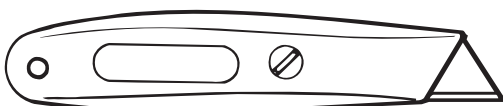

BLADES

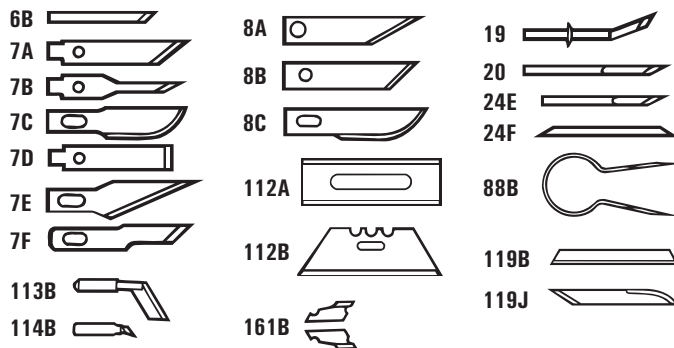

Specialty Tools



Pounce Wheels #9, #10, #11, #12

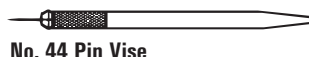

No. 44 Pin Vise

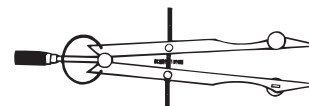

No. 2804 6" Bow Compass Circle Cutter

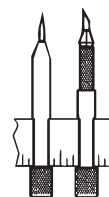

No. 108
Yardstick
Compass



No. 99 Mahlstick



No. 88 Adjustable Dual Cutter



No. 161 Dualflex Cutter

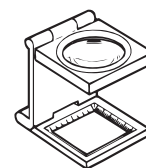

No. 62 Magnifier

Kits

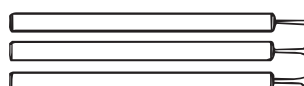

No. 18A Film Rule Cutting Set



No. 24-1 Stencil Kit

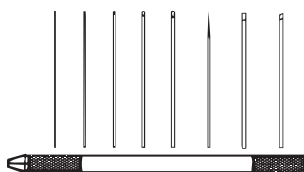

No. 22 Needle Cutter Set

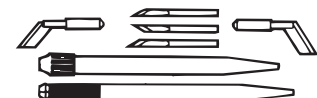

No. 113A Stencil Cutting Kit





Expand Your Cutting Solutions...Increase Production!

Cut any substrate faster, more accurately and more cost-effectively with cutters from Fletcher-Terry. They're safe, accurate, versatile, waste-free and easy to use!

3100[®]s Multi-Material Cutter

Get a clean, straight and precise cut every time from aluminum and plastics to foam board and glass up to 1/2" thick. Mounts easily to the wall for space-saving convenience. 63" cutting capacity.



PC[™] 40", 60", 120"

Cuts materials up to 1/2" from vinyl to GatorFoam[™] for quick and easy trimming up to 120" long. Lightweight and easy to store.



TrimMaster[™] 54 Plus & TrimMaster[™] 24

Accurately trims a wide variety of flexible, scissorable materials. Available in a 24" tabletop version or the 54" freestanding version (for cutting materials on a roll), with a material roll holder and catcher.



MISCELLANEOUS CUTTING MACHINES

Safety Speed Cut Manufacturing Co. Inc. Vertical Panel Saw

Safety Speed Cut offers a variety of vertical panel saws that are engineered to be low-cost, highly efficient, and extremely safe to use. Each machine has a guaranteed alignment built right into the machine and calibrated within factory specifications. Accessory equipment is also available to meet any special cutting requirement. *Contact Midwest for a complete product listing of Safety Speed Cut products.*



Federal Graphics Corner Cutting Machines

Two models available: table-top and floor models.

Table-top model cuts corners on 8 1/2" x 11" stock up to 1/2" thick and includes standard 1/4" cutting unit.

Floor model has a single-head, foot-pedal control and cuts 1/2" thick stock with standard 1/4" cutting blade. Additional blades for 3/8", 5/8" and 1/2" radius are available for the floor model only.



Don't forget to check out our complete line of substrates, starting on page 94.





With over 54 years of experience, Alvin is one of the primary sources for drafting supplies and drawing equipment in the country. They continue to meet the needs of multiple markets with an expanding range of fine art, hobby and craft supplies, and a large selection of drawing room furniture.

MULTI-PURPOSE CUTTING

Super Size Cutting Mat

Protect your table tops with our 4' x 8', 160-gauge ($\frac{1}{2}$ ") cutting mat. Make easier and straighter cuts with the aid of the alignment grid and centering rulers. The translucent non-glare surface is perfect for sign-makers and designers.



Multi-Purpose Cutting Mat

These mats are made of a 3-ply bonded composite material with a non-stick, non-marring, no-glare surface. Impervious to liquid spills and abrasions. Literally "heals" itself when cut.

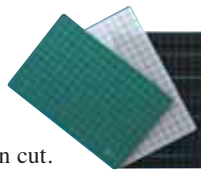

Two sizes available:

24" x 36" (1" grid, $\frac{1}{4}$ " graduations)

36" x 48" (1" grid, $\frac{1}{4}$ " graduations)

OLO Rolling Scissors

Makes scissors obsolete! Has an ergonomic design for painless cutting. Unique roller bearings make clean, smooth cuts.



Zippy Cutting Tools & Blades

Designed for cutting paper, cloth and plastic films. Knife available in assorted colors. Replacement blades available in packs of 12.



DRAWING ACCESSORIES

Aluminum Triangles

Lightweight, durable aluminum with matte-satin finish that resists stains and tarnishing. Features $\frac{1}{6}$ " graduations on the 90° angle. May also be used as a template for circles from $\frac{1}{6}$ " to 1 $\frac{3}{8}$ ".

45°/90° triangle available in 6" and 8" sizes.

30°/60° triangle available in 12" and 18" sizes.

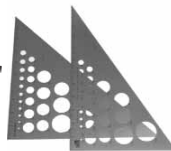

Stainless Steel Professional T-Squares

Features a 1 $\frac{1}{2}$ " wide, spring-tempered stainless steel blade with beveled edges for accurate line drawing and cutting. Available in 18", 24" and 30" sizes.



Heavy-Duty Aluminum Graduated T-Square Rules

Hefty 2"-wide, rigid aluminum blade with deeply cut, highly visible graduations. Features $\frac{1}{8}$ " and $\frac{1}{16}$ " graduations. Available in 36" and 60" sizes.

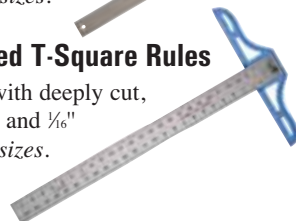

RULING & MEASURING

Large Profile Triangular 12" Scales

Professional scales produced with hard tempered anodized aluminum. Mechanically engraved markings in six different graduations. Supplied in a see-through case.



All-Plastic Triangular Scales

Budget-priced series of 12" triangular scales. Made of satin-finished impact plastic with easy-to-read black dye-imprinted graduations that will not wear or rub out.

Aluminum Straightedge Rules

Calibrated in black with graduations in $\frac{1}{6}$ " and $\frac{1}{8}$ " on opposite edges. Made of semi-rigid $\frac{1}{2}$ "-thick aluminum with a non-rust matte finish. Available in 12", 18" and 24".

Graduated Aluminum Straightedges

Hardened aluminum construction and a stain-resistant matte finish with clearly marked black graduations in $\frac{1}{6}$ " and $\frac{1}{8}$ " on opposite edges. Available in 36", 48", 60" and 72" sizes.



Eluxite Aluminum Centering Rules

Rigid but lightweight aluminum. Calibrated in $\frac{1}{2}$ " and $\frac{1}{6}$ ". Ideal for easily finding the center of two- or three-dimensional objects.

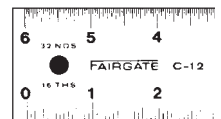

Neon Footage Measurer

Includes ring for convenient pocket use and large diameter for easy readout. One side is fitted with a special dial for exact measurement of lines and curves on technical plans, drawings and blueprints. The pointer indicates traced distance in inches and the counter registers in feet. Second dial measures scaled distances on maps or plans.



Scale Master II® Plan Measure

For the fastest, most accurate and versatile way to do "take-offs" from your graphics. Features 91 built-in scales with 8 customizable scales. Includes lithium batteries and case.

