

# N2 System

## Modular LED Sign System



**CIRRUS**  
LED SYSTEMS

Make any size and shape sign you want with this innovative N2 System from Cirrus LED! The N2 System is the only modular outdoor display system that can be controlled from wherever you have internet, giving you both flexibility and peace of mind.

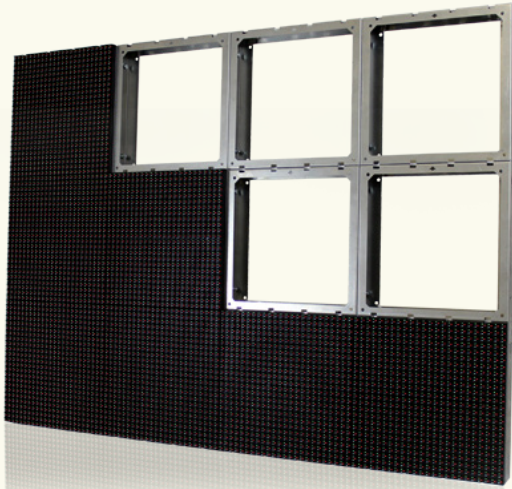

### N2 System Features

- Outdoor/waterproof design
- Full color LED panels
- Built-in power supply
- Frames mate-and-lock with each other for unlimited configurations in 12" squares
- 19 / 12.7 / 9.5mm Pixel Pitch
- Web-based control interface - the LED Cloud
- High efficiency - low power consumption
- 5 year warranty

### Why choose the N2 System?

#### Easily Customized

- Each N2 panel is 12" x 12" and can be combined into any shape or size sign
- Completely weatherproof and sealed with no fans or moving parts
- Can easily be built on site or in any sign shop

#### LED Cloud

- The "Cloud" interface allows you to create, edit and schedule content from any internet connected device (including smart phones and tablets)
- Add dynamic content such as weather, sports scores, financial data or social media feeds
- Upload photos and video to the full-featured editor to add vitality to your display

#### No Software Updates

- Your sign is remotely monitored and tested around the clock by Cirrus
- Using the cloud, you can control one sign or a network of signs from anywhere you have internet

The thinnest  
and *lightest*  
LED display  
available!

Midwest Part #	Description
CIRN219CF	19mm pitch color panel w/ frame
CIRN2127CF	12.7mm pitch color panel w/ frame
CIRN2CONTROL1	Controller-1 Led System Controller
CIRN2WIFIX2ENH200	Cirrus Wi-Fi Pair

**Ask your Midwest Representative today about the N2 Display System from Cirrus LED!**

**MINNESOTA**  
800-328-6592

**CALIFORNIA**  
800-824-2468

**MIDWEST**  
Sign & Screen Printing Supply Co.

**COLORADO**  
800-332-3819

**MISSOURI**  
800-233-3770

**NEBRASKA**  
800-228-3839

**OREGON**  
800-228-0596

**UTAH**  
800-497-6690

**WASHINGTON**  
800-426-4938





**WISCONSIN**  
800-242-7430

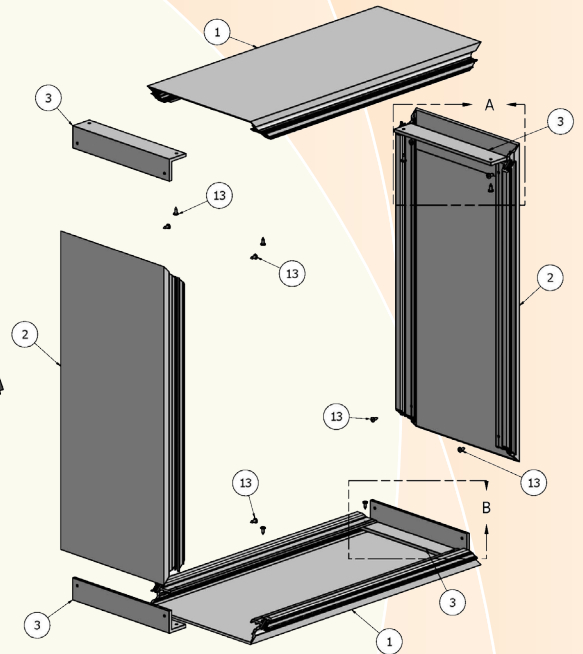
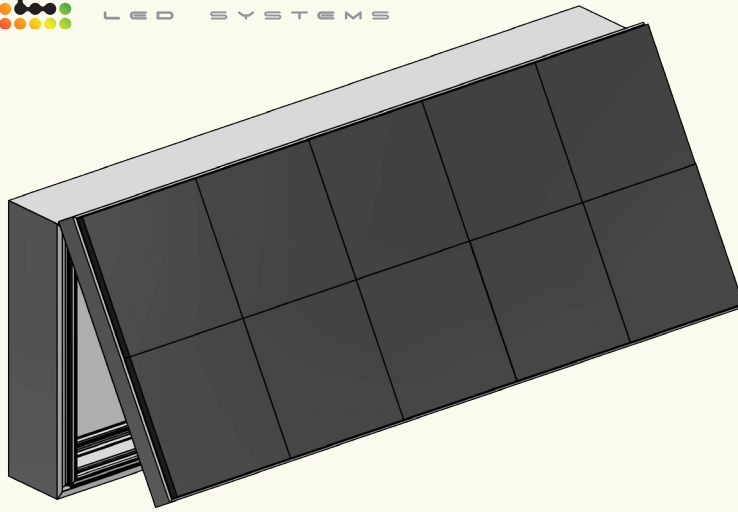

## Extrusions and Pre-Cut Kits for Cirrus LED!



### Extrusions

Extrusions	Part #	Description	Length	Finishes
	CS2081	LED Frame Retainer with Slots	23' - 5"	Mill Finish Dk Bronze
	2005	Wide Body	24' - 6"	Mill Finish Dk Bronze
	2015	Medium Body	24' - 6"	Mill Finish Dk Bronze
	2025	Single Face Body	24' - 6"	Mill Finish Dk Bronze
	2040	Retro Body	24' - 6"	Mill Finish

**Pre-Cut Kits** are available and ship within 2 days! Ask your Midwest Representative today for more information and pricing.

**MINNESOTA**  
800-328-6592

**CALIFORNIA**  
800-824-2468

**MIDWEST**  
Sign & Screen Printing Supply Co.

**COLORADO**  
800-332-3819

**MISSOURI**  
800-233-3770

**NEBRASKA**  
800-228-3839

**OREGON**  
800-228-0596

**UTAH**  
800-497-6690

**WASHINGTON**  
800-426-4938

**WISCONSIN**  
800-242-7430

